

G83563 Litte Farm House extra Chairs Assembly Instructions

For ages 3 and up.
Adult assembly required.

⚠ WARNING

Small parts and sharp points may be present prior to assembly.

Care Instructions

To clean your product, use mild soap and water on a damp cloth. Do not use window cleaners or cleaning abrasives as they will scratch the surface and could damage the protective coating.

Customer Service

For questions regarding this product, or to receive replacement or missing parts, contact Customer Service at (800) 524-3555. Please have the model number and part number(s) located in this Assembly Instruction sheet available for reference.

Limited Warranty

All Guidecraft products are warranted to the original purchaser at the time of purchase and for a period of one (1) year thereafter. In order to provide you with timely assistance, please thoroughly inspect your product for missing or defective parts immediately after opening the carton. To receive replacement or missing parts under this warranty, contact Customer Service. You will also need your sales receipt or other proof of purchase.

Hardware and Parts

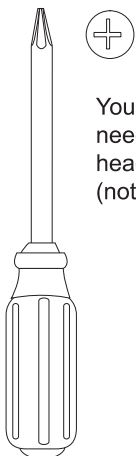
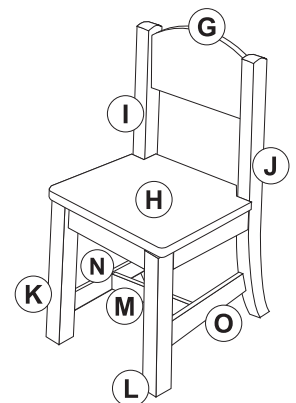
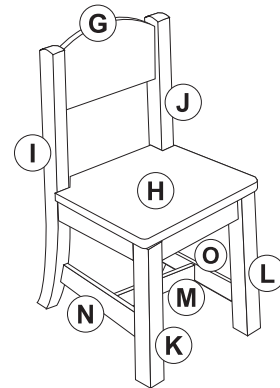
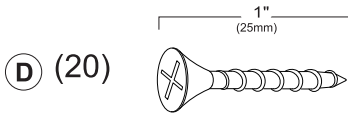
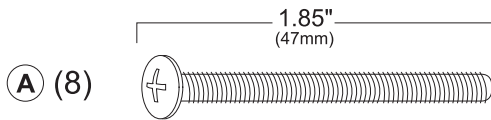

You will also need a Phillips-head screwdriver (not included).

Chair Assembly

Quick Tips:

1. The back chair legs (J and I) — when assembled to backrest (G) correctly — will have the curve of the leg facing back and away from the chair. The inset nut should be facing towards the center of the seat, as shown below. Lay out your parts first for both chairs so as not to mismatch legs during assembly.
2. Assemble backrest to back legs (shown at right), prior to assembling back legs to seat.

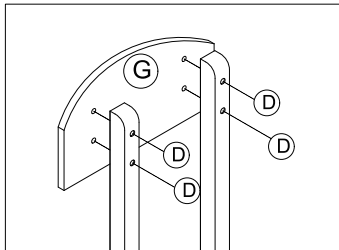

Step 1

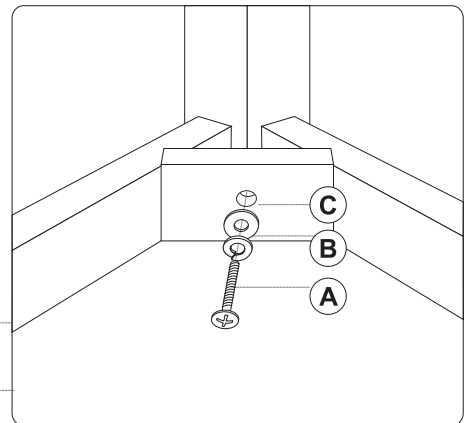

Step 3

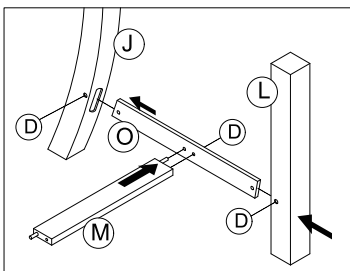

Step 2

